

Cavity-Tooling:08W-2

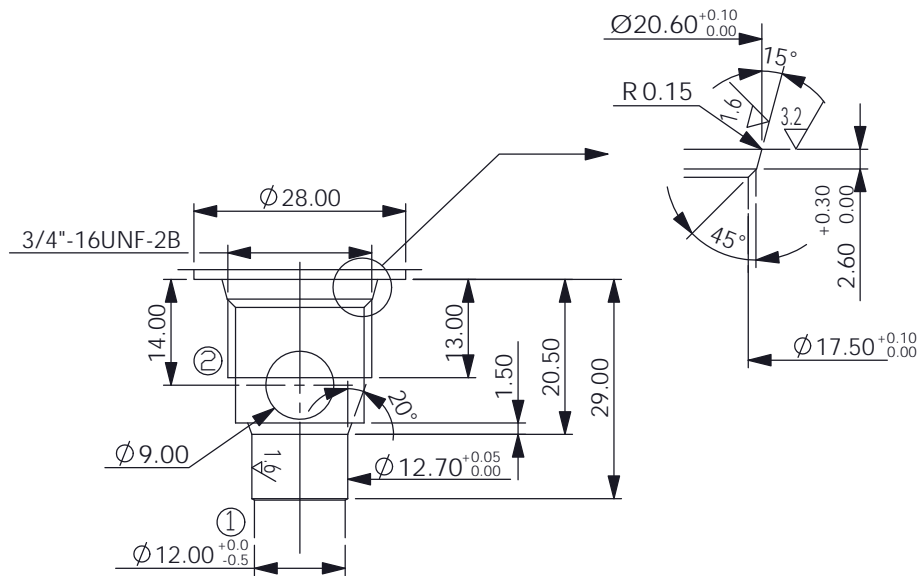

0.03

0.02

UNIT:mm

Cavity-Tooling:10W-2

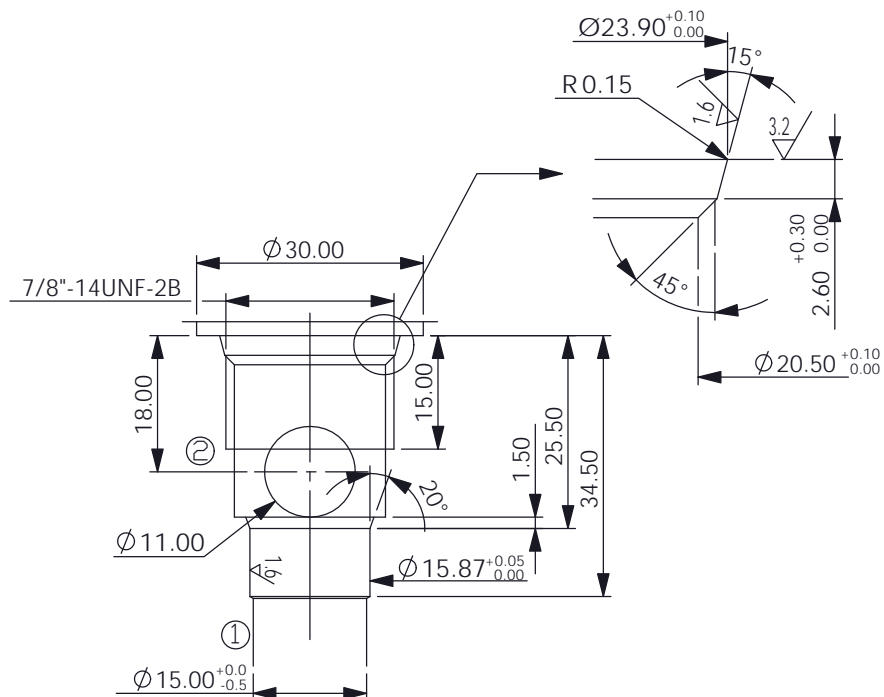

0.03

0.02

UNIT:mm