

訂購編號: **NV-08W-X-Y-Z**

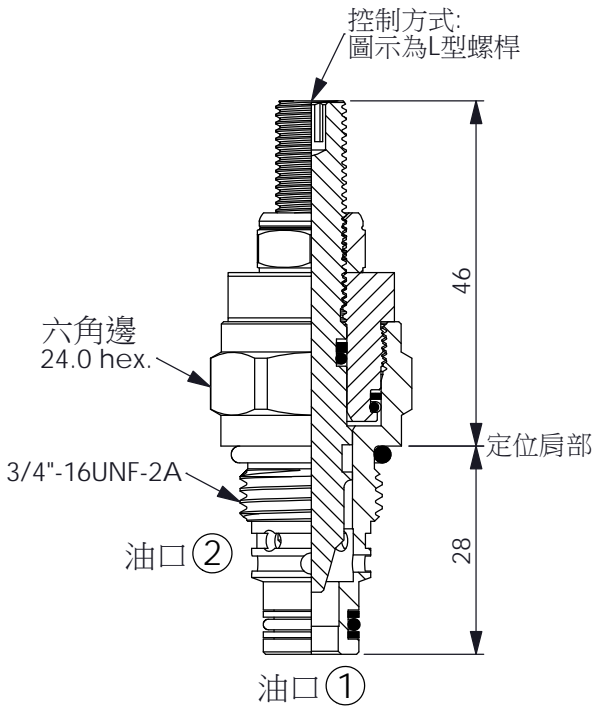

尺寸單位:mm

性能曲線圖

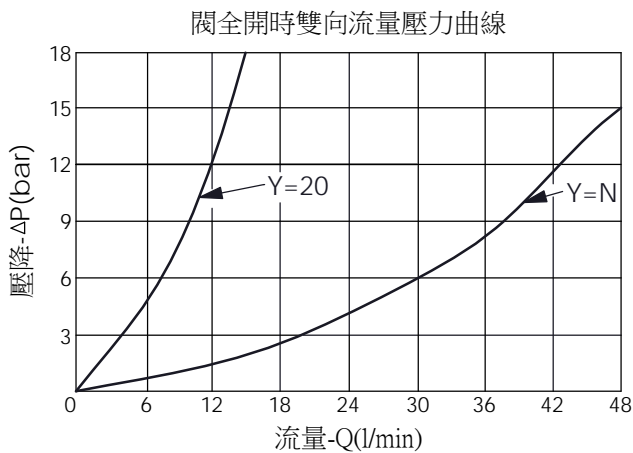

Y 最大公稱節流孔徑

N ϕ 5.6 mm

20 ϕ 2.0 mm

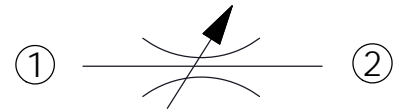

技術參數

額定壓力:	350	bar
	(參考性能曲線圖)	
額定流量:	36	l/min
	(參考性能曲線圖)	
成型孔:	08W-2	
安裝扭矩:	25-35	Nm
重量:	0.13 (Z:L)	kg

此閥可確定實關閉,而無漏油
額定流量僅供參考,實際流量視使用的壓降而定

X 結構設計選項

20 全調型節流閥針閥結構

Z 控制方式選項

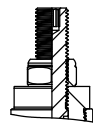
L 標準內六角螺桿 

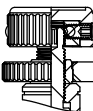
K 調鈕附設定鈕 

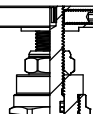
E 鋁合金調鈕
附螺帽設定 

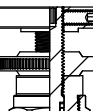
B 鋁合金調鈕
附鋁合金設定鈕 

T 三爪強力旋鈕
附鋁合金設定鈕 